



AC/DC

MED

# ISOMETER® isoMED427x-(PT)

Insulation monitoring device for medical applications





## Table of contents

<b>1</b>	<b>General information.....</b>	<b>5</b>
1.1	How to use the manual.....	5
1.2	Indication of important instructions and information.....	5
1.3	Signs and symbols.....	5
1.4	Service and Support.....	5
1.5	Training courses and seminars.....	6
1.6	Delivery conditions.....	6
1.7	Inspection, transport and storage.....	6
1.8	Warranty and liability.....	6
1.9	Disposal of Bender devices.....	7
1.10	Safety.....	7
<b>2</b>	<b>Device-specific safety information.....</b>	<b>8</b>
2.1	Intended use.....	8
<b>3</b>	<b>Functional description.....</b>	<b>9</b>
3.1	Alarm and operating messages for each BMS channel.....	10
<b>4</b>	<b>Mounting and connection.....</b>	<b>11</b>
4.1	Wiring diagram.....	12
4.2	Commissioning.....	12
<b>5</b>	<b>Operating elements.....</b>	<b>13</b>
5.1	Display elements isoMED427x-(PT).....	13
5.2	Display in standard mode.....	14
5.3	Alarm indication and EDS activity.....	14
<b>6</b>	<b>Parameter settings.....</b>	<b>15</b>
6.1	Menu overview.....	16
6.2	Setting the response value $R_{an}$ (<R).....	17
6.3	Setting the response value for load current monitoring.....	17
6.4	Setting the response value overtemperature (>°C) (isoMED427P-PT).....	17
6.5	Setting the operating principle of the alarm relay.....	17
6.6	Setting the BMS address.....	17
6.7	Activating automatic insulation fault location.....	17
6.8	Password protection.....	17
6.9	Deactivating the CT monitoring function.....	18
6.10	Resetting the device to factory settings.....	19
6.11	Querying device information.....	19

<b>7</b>	<b>Technical data isoMED427(P)-(PT).....</b>	<b>20</b>
7.1	Factory settings isoMED427x-(PT).....	24
7.2	Ordering data.....	25
7.3	Recommended device combinations.....	25
7.4	Standards and certifications.....	25
7.5	Change log.....	26

## 1 General information

### 1.1 How to use the manual

**ADVICE**

This manual is intended for qualified personnel working in electrical engineering and electronics! Part of the device documentation in addition to this manual is the enclosed supplement "Safety instructions for Bender products".

**ADVICE**

Read the operating manual before mounting, connecting and commissioning the device. Keep the manual within easy reach for future reference.

### 1.2 Indication of important instructions and information

**DANGER**

Indicates a high risk of danger that will result in death or serious injury if not avoided.

**WARNING**

Indicates a medium risk of danger that can lead to death or serious injury if not avoided.

**CAUTION**

Indicates a low-level risk that can result in minor or moderate injury or damage to property if not avoided.

**ADVICE**

Indicates important facts that do not result in immediate injuries. They can lead to malfunctions if the device is handled incorrectly.



*Information can help to optimise the use of the product.*

### 1.3 Signs and symbols



Disposal



Protect from moisture



Protect from dust

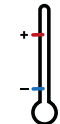

Temperature range



Recycling



RoHS directives

### 1.4 Service and Support

Information and contact details about customer service, repair service or field service for Bender devices are available on the following website: Fast assistance | Bender GmbH & Co. KG.

## 1.5 Training courses and seminars

Regular face-to-face or online seminars for customers and other interested parties:

[www.bender.de](http://www.bender.de) > know-how > seminars.

## 1.6 Delivery conditions

The conditions of sale and delivery set out by Bender GmbH & Co. KG apply. These can be obtained in printed or electronic format.

The following applies to software products:



"Software clause in respect of the licensing of standard software as part of deliveries, modifications and changes to general delivery conditions for products and services in the electrical industry"

## 1.7 Inspection, transport and storage

Check the shipping and device packaging for transport damage and scope of delivery. In the event of complaints, the company must be notified immediately, see "[www.bender.de](http://www.bender.de) > service & support".

The following must be observed when storing the devices:

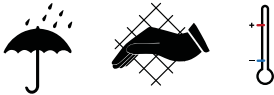

## 1.8 Warranty and liability

Warranty and liability claims for personal injury and property damage are excluded in the case of:

- Improper use of the device.
- Incorrect mounting, commissioning, operation and maintenance of the device.
- Failure to observe the instructions in this operating manual regarding transport, commissioning, operation and maintenance of the device.
- Unauthorised changes to the device made by parties other than the manufacturer.
- Non-observance of technical data.
- Repairs carried out incorrectly.
- The use of accessories or spare parts that are not provided, approved or recommended by the manufacturer.
- Catastrophes caused by external influences and force majeure.
- Mounting and installation with device combinations not approved or recommended by the manufacturer.

This operating manual and the enclosed safety instructions must be observed by all persons working with the device. Furthermore, the rules and regulations that apply for accident prevention at the place of use must be observed.

## 1.9 Disposal of Bender devices

Abide by the national regulations and laws governing the disposal of this device.



For more information on the disposal of Bender devices, refer to [www.bender.de](http://www.bender.de) > service & support.

## 1.10 Safety

If the device is used outside the Federal Republic of Germany, the applicable local standards and regulations must be complied with. In Europe, the European standard EN 50110 applies.



**DANGER** *Risk of fatal injury due to electric shock!*

*Touching live parts of the system carries the risk of:*

- Risk of electrocution due to electric shock
- Damage to the electrical installation
- Destruction of the device

Before installing the device and before working on its connections, make sure that the installation has been de-energised. The rules for working on electrical systems must be observed.

## 2 Device-specific safety information

**CAUTION Risk of property damage due to unprofessional installation!**

If more than one insulation monitoring device is connected to a conductively connected system, the system may be damaged. If several devices are connected, the device does not work and does not signal insulation faults.

Make sure that only one insulation monitoring device is connected in each conductively connected system.

**CAUTION Ensure disconnection from the IT system!**

When insulation or voltage tests are to be carried out, the device must be isolated from the system for the test period. Otherwise the device may be damaged.



Only one ISOMETER® may be connected to a system to be monitored.

### 2.1 Intended use

ISOMETER®s of the isoMED427x-(PT) series monitor the insulation resistance  $R_p$  of a medical IT system with AC 70...264 V. In addition, the load current and the temperature of the IT system transformer are monitored. Alarms and measured values are provided to other bus devices via the BMS interface. For display and signalling purposes, the use of special alarm indicator and test combinations is recommended.

Devices of the isoMED427x-(PT) series do not require an additional supply voltage. The maximum permissible system leakage capacitance is 5  $\mu$ F.

After detection of an insulation fault, the internal locating current injector of the isoMED427P-(xx) models enables insulation fault location. The use of special devices of the EDS series is recommended to locate the insulation fault.

In order to meet the requirements of the applicable standards, customised parameter settings must be made on the equipment in order to adapt it to local equipment and operating conditions. Please heed the limits of the range of application indicated in the technical data.

Any other use or a use that goes beyond this constitutes improper use.



If the ISOMETER® is installed inside a control cabinet, the insulation fault message must be audible and/or visible to attract attention.



### 3 Functional description

During regular operation, the display shows the present insulation resistance. Use the arrow-up or arrow-down button to display the present load current in %. The isoMED427P-PT also displays the present transformer temperature. If the insulation resistance falls below the response value, the AL1 LED signals an insulation fault. AL2 lights up if the load current is too high or the temperature of the monitored IT system transformer is too high. The alarm relay K1 signals all alarm categories. In addition, a bus signal is provided at terminals A, B for insulation fault locators as well as alarm indicator and test combinations.

The detected insulation fault activates the internal locating current injector for insulation fault location if the EDS function was previously enabled in the menu (factory setting = off). A positive and a negative locating current pulse is injected into the monitored IT system alternately for 2 s each. There is a 4 s pause between positive and negative pulse.

The isoMED427P-(PT) models can only be operated as BMS slave. Therefore, the alarm indicator and test combination or the respective insulation fault locator take over the master function. BMS masters always have BMS address 1.

#### Automatic self test

The device runs a self test after connecting the supply voltage and after that every hour. During the self test, internal malfunctions or connection faults are detected and shown as an error code on the display. The alarm relay is not switched during the self test.

#### Manual self test

The device runs a self test after pressing the test button "T" or the external test button for > 2 s. Any internal malfunctions or connection faults detected during this test are shown as an error code on the display. The alarm relay is switched during the self test.

While the test button "T" is pressed, all display elements available for this device are shown.

#### Malfunction

In the event of a malfunction, relay K1 switches and all three LEDs flash. The display shows an error code.

E.01	Protective conductor connection faulty, no low-resistance connection between E and KE.
E.03	Measuring current transformer interruption
E.04	Measuring current transformer short circuit
E.05...E.xx	Internal device error, contact Bender service.

#### Password protection

If the password protection has been enabled, settings can only be made after entering the correct password.

#### Factory settings FAC

After restoring the factory settings, all settings previously changed are reset to the state upon delivery.

### Monitoring of the IT system transformer

For temperature monitoring, the isoMED427P-PT device evaluates the resistance value of the temperature sensor. If the switching threshold of 4 k $\Omega$  (isoMED427x) or the set temperature value (isoMED427P-PT) is reached, an overtemperature alarm is triggered. The display shows "> °C".



#### ADVICE

Temperature values are only displayed on the isoMED427P-PT.



#### ADVICE

To avoid overloading the transformer, the load current and temperature must always be monitored simultaneously. Please observe the wiring diagram!

### 3.1 Alarm and operating messages for each BMS channel

isoMED427P and isoMED427P-PT provide alarm and operating messages for other bus devices. These can be queried by a BMS master, e.g. an alarm indicator and test combination.

#### Alarm messages

BMS channel	Description
1	Insulation fault: Insulation resistance $R_f$ below the response value $R_{an}$
2	Overcurrent in %: Load current above the response value
3	Overtemperature: Transformer temperature above the response value
4	Connection fault PE
5	CT connection for current measurement interrupted
6	CT connection for current measurement short-circuited
7	Device error, internal
9	Start of the EDS system in continuous operation without pause time

#### Operating messages

BMS channel	Description
1	Currently measured insulation resistance $R_f$
2	Currently measured load current in %
8	Current transformer temperature in °C (isoMED427P-PT only)

## 4 Mounting and connection



**DANGER Risk of fatal injury due to electric shock!**

Touching live parts of the system carries the risk of an electric shock.

- Before installing and connecting the device, make sure that the installation has been de-energised.
- The rules for working on electrical systems must be observed.

### Dimensional drawing

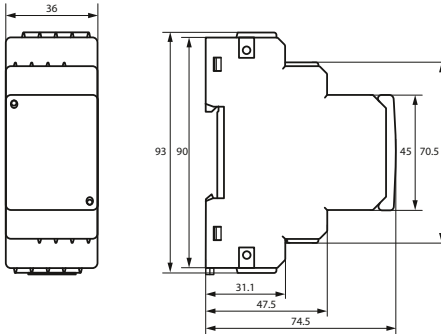

• **DIN rail mounting:**

Snap the rear mounting clip of the device into place in such a way that a safe and tight fit is ensured.

• **Screw mounting:**

A second mounting clip is required (see ordering information). Use a tool to place the mounting clips in a position that protrudes beyond the enclosure. Fix the device with two M4 screws, see sketch.

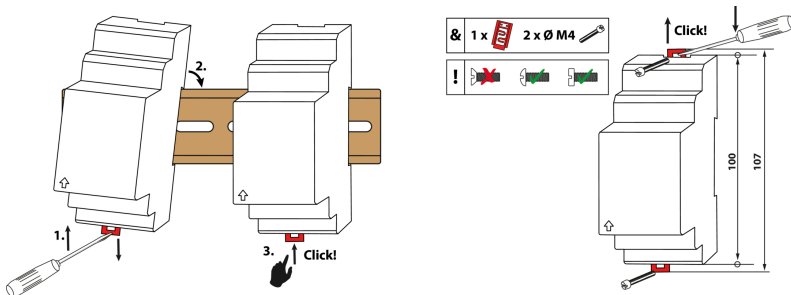

## 4.1 Wiring diagram



### **DANGER** Risk of electrocution due to electric shock!

If terminals L1, L2 of the device are connected to an energised IT system, terminals E and KE must not be disconnected from the protective conductor (PE).

Connect the device according to the wiring diagram.

The lines to KE and E must be routed separately!

The BMS bus must be terminated at both ends!

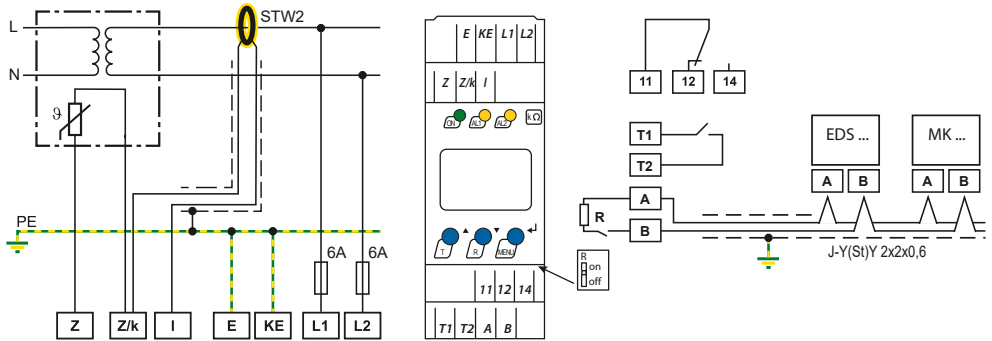

Terminal	Connections
<b>E, KE</b>	Separate connection of E and KE to PE
<b>L1, L2</b>	Connection to the IT system to be monitored; supply voltage (see nameplate) via 6 A fuse
<b>Z, Z/k</b>	Connection to temperature sensor acc. to DIN44081 (isoMED427x) Connection to temperature sensor PT100 (isoMED427P-PT)
<b>Z/k, I</b>	Connection to measuring current transformer (STW2)
<b>T1, T2</b>	Connection to external test button
<b>A, B</b>	RS-485 interface, terminate connection to R switch (on/off), when the device is connected to the bus end.
<b>11, 12, 14</b>	Alarm relay K1

## 4.2 Commissioning

Prior to commissioning, check proper connection of the ISOMETER®.



Perform a functional test using a genuine earth fault, e.g. via a suitable resistance.

## 5 Operating elements

Device front	Element	Function
		Power on LED
		Alarm LED 1 is lit: Below response value $R_{an}$
		Alarm LED 2 is lit: Response value % I or/and °C exceeded
		"T": Start a self test (2 s) ▲: Menu item up / increase value
		▼: Menu item down / decrease value
		Start menu mode (2 s) Enter button: (< 1.5 s): Confirm menu item, submenu item, value. (> 2 s): Return to the next higher menu level

### 5.1 Display elements isoMED427x-(PT)

After activating the test function (T), all available display elements are shown for 2 seconds.

	< >	Identifier for response values
	7-segment display	Display of the values
	Upper row	R : Insulation resistance I : Fault current .: Measuring pulse (flashing) 1 : Relay
	%   °C k   M   Ω A	Measurement units (°C for isoMED427P-PT only)
	on   off	State values
	Adr	BS bus address enabled
		Relay operating mode
		Password protection enabled

## 5.2 Display in standard mode

If there is no alarm pending, the ON LED is lit and the currently measured values are shown on the display. The arrow-up/arrow-down buttons can be used to switch between the insulation resistance value, the percentage load current and the transformer temperature. If the Enter button is pressed after changing the display, the displayed measurement category remains.

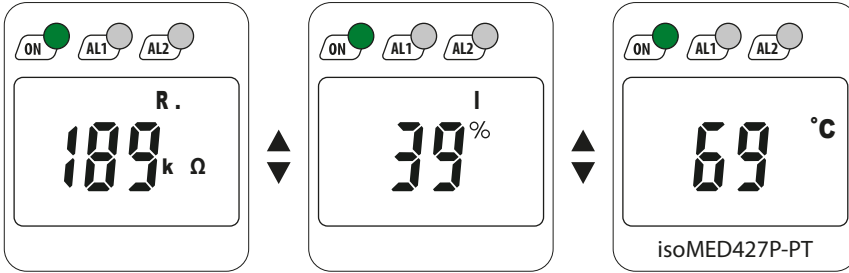

## 5.3 Alarm indication and EDS activity

Display examples:

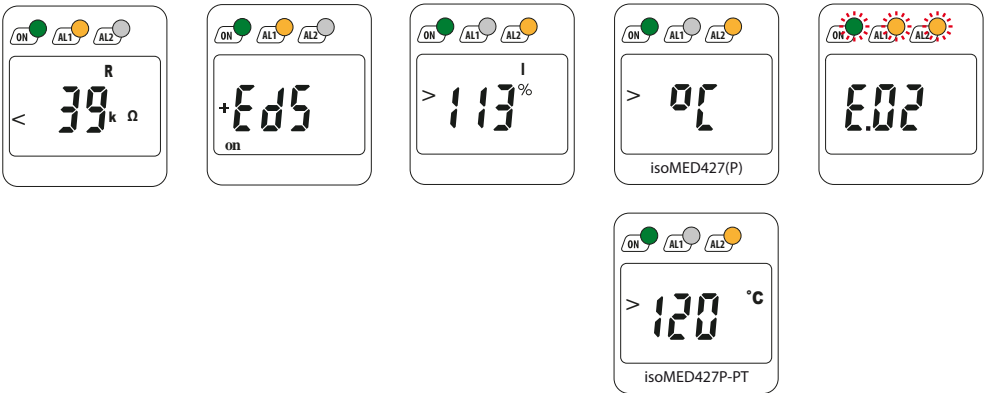

If different alarms occur simultaneously, the display changes at 3-second intervals. If several errors occur, the respective error codes are displayed alternately.

## 6 Parameter settings

An example is given below on how to change the alarm response value  $R_{an}$  (< R). Proceed as follows:

1. Press and hold the MENU/Enter button for 2 s. The flashing short symbol < R appears on the display.
2. Confirm with Enter. A flashing display shows the currently set response value in kΩ.
3. Use the arrow-up or arrow-down button to set the appropriate value. Confirm with Enter. The flashing short symbol < R appears.
4. The following options are available to exit the menu:
  - Press and hold the Enter button for 2 s to go up one menu level
  - Select the menu item ESC and confirm with Enter to go up one menu level.

**i** *The areas of the display which can be configured flash! In the figures below, the segments where device settings can be carried out are highlighted by an oval*  
*menu mode can be accessed by pressing and holding the "MENU" button for 2 s.*

## 6.1 Menu overview

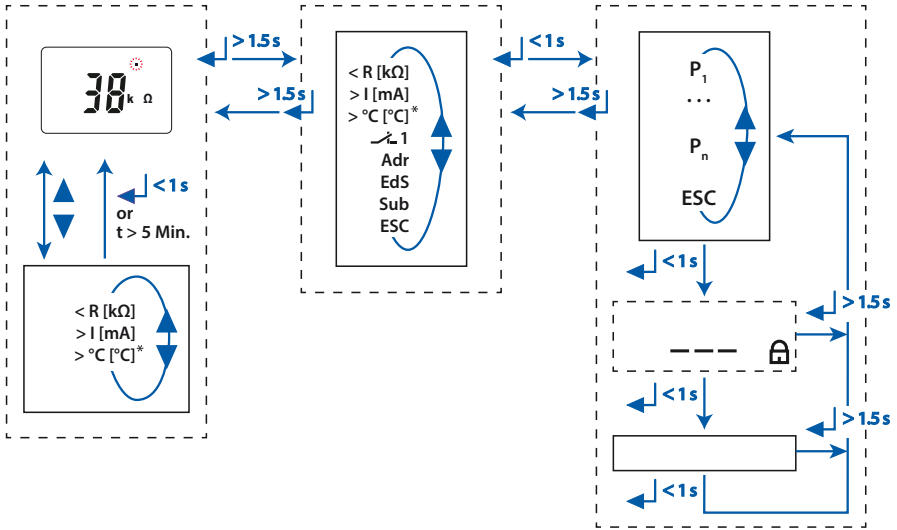

\* The current temperature is only displayed on the isoMED427P-PT model.

Menu		Configurable parameters
< R		Query and set the insulation monitoring response value
> I		Query and set the load current monitoring response value in A
> °C		Set the response value for overtemperature (isoMED427P-PT only)
		Select N/O or N/C operation for K1
Adr		Setting the BMS address
EdS		Activate or deactivate automatic insulation fault location
Sub		Access to the submenu and return from the submenu
		Enable or disable password protection, change password
	ct	Activate or deactivate CT monitoring
	FAC	Restore factory settings
	InF	Query software version
	ESC	Next higher menu level
	SYS	Service menu SyS locked
ESC		Exit menu



## 6.2 Setting the response value $R_{an}$ (<R)

Use this setting to define the insulation value below which an alarm is signalled.

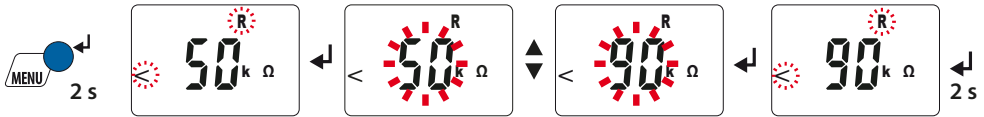

## 6.3 Setting the response value for load current monitoring



## 6.4 Setting the response value overtemperature (> $^{\circ}\text{C}$ ) (isoMED427P-PT)

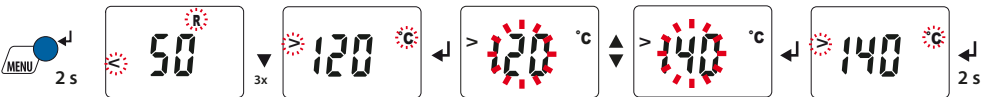

## 6.5 Setting the operating principle of the alarm relay

Use this menu to set the operating principle of the alarm relay K1 (1) to N/O operation (n.o.) or N/C operation (n.c.):



## 6.6 Setting the BMS address



## 6.7 Activating automatic insulation fault location



## 6.8 Password protection

This menu can be used to enable the password protection, change the password or to disable the password protection.

The password can only be changed if the password protection has been enabled before.

**a) Enabling the password protection**

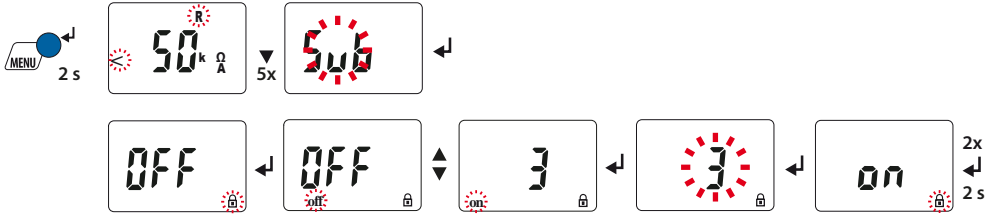

**b) Changing the password**

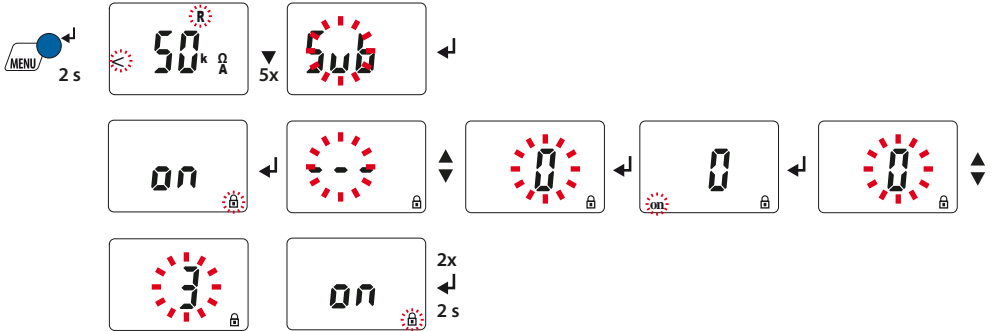

**c) Disabling the password protection**

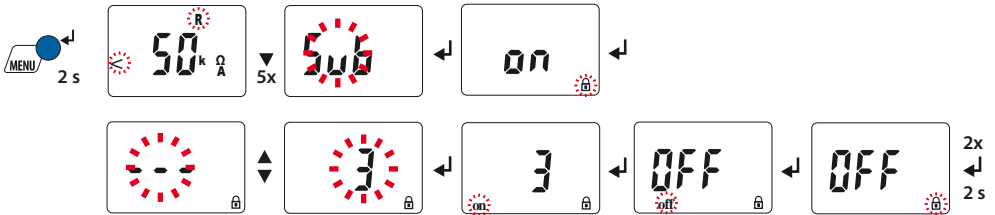

**6.9 Deactivating the CT monitoring function**

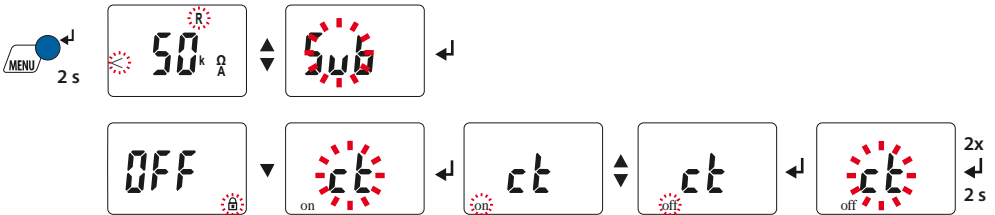

### 6.10 Resetting the device to factory settings

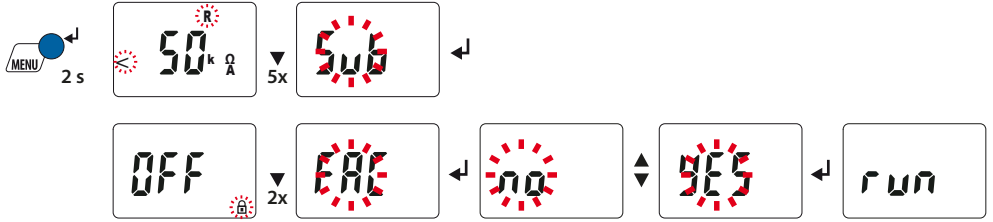

### 6.11 Querying device information

This function is used to query the software (1.xx) version. After activating this function, the data will be displayed as scrolling text. After completing the routine, individual data sections can be selected using the arrow-up/arrow-down buttons.

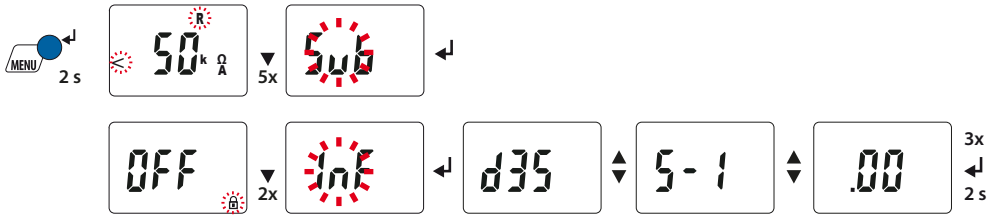

## 7 Technical data isoMED427(P)-(PT)

### Insulation coordination acc. to IEC 60664-1/-3

#### Definitions

Measuring circuit (IC1)	L1, L2
Control circuit (IC2)	E, KE, Z, Z/k, I, T1, T2, A, B
Output circuit (IC3)	11, 12, 14
Rated voltage	250 V
Overvoltage category	III
Operating altitude	< 2000 m AMSL

#### Rated impulse voltage

IC1/(IC2-3)	4 kV
IC2/IC3	4 kV

#### Rated insulation voltage

IC1/(IC2-3)	250 V
IC2/IC3	250 V
Pollution degree	3

#### Protective separation between

IC1/(IC2-3)	Overvoltage category III, 300 V
IC2/IC3	Overvoltage category III, 300 V

#### Voltage test (routine test) according to IEC 61010-1

(IC1-2)/IC3	2.2 kV
-------------	--------

#### Supply voltage

Supply voltage $U_s$	100...240 V
Tolerance $U_s$	-30...10 %
Power consumption	6.5 VA

#### Monitored IT system

Nominal system voltage $U_n$	70...264 V
Nominal frequency $f_n$	47...63 Hz

**Insulation monitoring acc. to IEC 61557-8: 2007-01**

Response value $R_{an}$	50...500 k $\Omega$
Relative uncertainty	$\pm 10\%$
Hysteresis	25 %
Response time $t_{an}$ at $R_F = 0.5 \times R_{an}$ and $C_e = 0.5 \mu\text{F}$	$\leq 5$ s
Response time for connection monitoring PE	$\leq 1$ h
Permissible system leakage capacitance $C_e$	max. 5 $\mu\text{F}$

**Locating current injector acc. to IEC61557-9**

Locating current	$\leq 1$ mA
Test pulse/break	2/4 s

**Measuring circuit**

Measuring voltage $U_m$	$\pm 12$ V
Measuring current $I_m$ at $R_F = 0 \Omega$	$\leq 50 \mu\text{A}$
Internal DC resistance $R_i$	$\geq 240$ k $\Omega$
Impedance $Z_i$ at 50 Hz	$\geq 200$ k $\Omega$
Permissible extraneous DC voltage $U_{fg}$	$\leq$ DC 300 V

**Load current monitoring**

Response value adjustable	5...50 A
Relative uncertainty	$\pm 5\%$
Hysteresis	4 %
Nominal frequency $f_n$	47...63 Hz
Setting values load current measurement	
Transformer	3150 VA / 4000 VA / 5000 VA / 6300 VA / 8000 VA / 10,000 VA
$I_{alarm1}$	14 A / 18 A / 22 A / 28 A / 35 A / 45 A
Response time, overload (50 % to 120 %)	$< 5$ s
Response time, CT monitoring	at restart, test or every 1 h

## Temperature monitoring

### isoMED427x

Sensor	PTC resistors acc. to DIN 44081 (max. 6 in series)
Response value	4 k $\Omega$
Release value	1.6 k $\Omega$
Relative uncertainty	$\pm 10\%$
Response time, overtemperature	< 2 s

### isoMED427P-PT

Sensor	PT100 (no series or parallel connections)
Response value	50...150 °C
Hysteresis	10 %
Relative uncertainty	$\pm 5\%$
Response time, overtemperature	< 5 s

## Displays, memory

Display	LC display, multi-functional, not illuminated
Display range measured value insulation resistance ( $R_f$ )	10 k $\Omega$ ... 1 M $\Omega$
Operating uncertainty	$\pm 10\%$ , $\pm 2$ k $\Omega$
Measured value load current (as % of the set response value)	10...199 %
Operating uncertainty	$\pm 5\%$ , $\pm 0.2$ A
Password	off, on [0...999]

## Interface

Interface/protocol	RS-485/BMS
Baud rate	9.6 kBit/s
Cable length	$\leq 1200$ m
Cable: twisted pair, one end of shield connected to PE	recommended J-Y(St)Y min. $n \times 2 \times 0.8$
Terminating resistor	120 $\Omega$ (0.25 W), internal, switchable
Device address, BMS bus	2...90

## Switching elements

Number	1 changeover contact
Operating principle	N/C operation / N/O operation
Electrical endurance under rated operating conditions	10,000 cycles

### Contact data acc. to IEC 60947-5-1

Utilisation category	AC-13 / AC-14 / DC-12 / DC-12 / DC-12
Rated operational voltage	230 V / 230 V / 24 V / 110 V / 220 V
Rated operational current	5 A / 3 A / 1 A / 0.2 A / 0.1 A
Minimum contact load	10 mA / DC 5 V

## Environment/EMC

EMC	IEC 61326-2-4
Operating temperature	-25...55 °C

### Classification of climatic conditions acc. to IEC 60721 (related to temperature and relative humidity)

Stationary use (IEC 60721-3-3)	3K22
Transport (IEC 60721-3-2)	2K11
Long-term storage (IEC 60721-3-1)	1K22

### Classification of mechanical conditions acc. to IEC 60721

Stationary use (IEC 60721-3-3)	3M11
Transport (IEC 60721-3-2)	2M4
Long-term storage (IEC 60721-3-1)	1M12

## Connection

Connection type	Push-wire terminals
Nominal current	≤ 10 A
Stripping length	10 mm
Opening force	50 N
Test opening, diameter	2.1 mm
Connection properties:	
rigid	0.2...2.5 mm <sup>2</sup> (AWG 24...14)
flexible without ferrule	0.75...2.5 mm <sup>2</sup> (AWG 19...14)
flexible with ferrule	0.2...1.5 mm <sup>2</sup> (AWG 24...16)

Connection type	Screw-type terminals
Nominal current	≤ 10 A
Tightening torque	0.5...0.6 Nm (5...7 lb-in)
Cross section	AWG 24-12
Stripping length	8 mm
Connection properties:	
rigid/flexible	0.25...2.5 mm <sup>2</sup>
Flexible with ferrules with/without plastic sleeve	0.25...2.5 mm <sup>2</sup>
Multi-conductor rigid/flexible	0.2...1.5 mm <sup>2</sup>
Multi-conductor flexible with ferrule without plastic sleeve	0.25...1.5 mm <sup>2</sup>
Multi-conductor flexible with TWIN ferrule with plastic sleeve	0.25...1.5 mm <sup>2</sup>

## Other

Operating mode	Continuous operation
Position of normal use	Any
Degree of protection, built-in components (DIN EN 60529)	IP30
Degree of protection, built-in components (DIN EN 60529)	IP20
Enclosure material	Polycarbonate
Flammability class	UL94V-0
DIN rail mounting	IEC 60715
Screw mounting	2 × M4
Software versions	D643 V1.0x (isoMED427-2) D355 V1.0x (isoMED427P-2) D644 V 1.0x (isoMED427P-PT)
Weight	≤ 150 g

## 7.1 Factory settings isoMED427x-(PT)

Response value $R_{an}$ :	50 kΩ (< R)
Response value $I_{alarm}$ :	7 A (> I)
Response value °C:	4 kΩ (fixed value for isoMED427x) 120 °C (configurable for isoMED427P-PT)
Operating principle K1:	N/C operation (n.c.)
BMS address:	3



Automatic insulation fault location:	off, deactivated
Password:	0, disabled
CT monitoring:	on, activated
Termination:	off, deactivated (120 Ω)

## 7.2 Ordering data

### ISOMETER®

Model	Supply voltage $U_s$	Article number	
		Push-wire terminals	Screw-type terminals
isoMED427-2	AC 70...264 V; 47...63 Hz	B72075306	B92075306
isoMED427P-2 <sup>*)</sup>		B72075301	B92075301
isoMED427P-PT		B72075307	B92075307

<sup>\*)</sup> Only this device has a Lloyds Register approval

### Accessories

Description	Article number
Mounting clip for screw mounting	B98060008
XM420 mounting frame	B990994
STW2 measuring current transformer for ISOMETER® isoMED427P	B942709
E0107 temperature sensor for ISOMETER® isoMED427P	B924186

## 7.3 Recommended device combinations

Device combination	Insulation monitoring device	Insulation fault locator	Alarm indicator and test combination
1	isoMED427P(-PT) = S	EDS461-L = S EDS461-D = S	MK2430, CP9xx, CP305 = M MK2007 = S
2	isoMED427P(-PT) = S	EDS151 = S	MK2430, CP9xx, CP305 = M MK2007 = S
S = Slave, M = Master			

## 7.4 Standards and certifications

The ISOMETER® was developed in compliance with the following standards:

- DIN EN 61557-8 (VDE 0413-8): 2015-12/Ber1: 2016-12
- IEC 61557-8: 2014/COR1: 2016
- EN 61373 cat I class B



**i** *The Lloyd's Register certification is only valid for the spring-type terminal version of the isoMED427P-2 (B72075301).*

### EU Declaration of Conformity

The EU Declaration of Conformity is available at the following Internet address:

[https://www.bender.de/fileadmin/content/Products/CE/CEKO\\_isoMED427P-2.pdf](https://www.bender.de/fileadmin/content/Products/CE/CEKO_isoMED427P-2.pdf)

### 7.5 Change log

Date	Document version	Valid from software version	State/Changes
05.2022	00	-	First edition
02.2024	01	-	Graphic corrected: "Deactivating the CT monitoring function", page 18 Link added to CE declaration of conformity: "Standards and certifications", page 25 Change log added. New design implemented.
04.2024	02	-	<ul style="list-style-type: none"> <li>Standards deleted: DIN EN 50155; EN 45545-2</li> <li>EAC mark deleted</li> <li>Technical data: Locating current injector added</li> </ul>
07.2024	03	-	Technical data: Power consumption changed to 6.5 VA



**Bender GmbH & Co. KG**

Londorfer Straße 65  
35305 Grünberg  
Germany

Tel.: +49 6401 807-0  
info@bender.de  
www.bender.de

Alle Rechte vorbehalten.  
Nachdruck und Vervielfältigung nur mit  
Genehmigung des Herausgebers.

All rights reserved.  
Reprinting and duplicating only with  
permission of the publisher.



© Bender GmbH & Co. KG, Germany  
Subject to change! The specified  
standards take into account the edition  
valid until 07.2024 unless otherwise  
indicated.