

ISOMETER[®] iso685(W)-x-B

Insulation Monitoring Device for IT AC systems
with galvanically connected rectifiers and inverters and
for IT DC systems



ISOMETER® iso685(W)-x-B

Insulation Monitoring Device for IT AC systems
with galvanically connected rectifiers and inverters and
for IT DC systems



Intended use

The ISOMETER® monitors the insulation resistance of unearthed AC/DC main circuits (IT systems). For the iso685-x and iso685-x-B types, the operating range of the nominal voltage U_n can be extended via coupling devices.

DC components existing in AC/DC systems do not influence the operating characteristics. A separate supply voltage allows de-energised systems to be monitored too. The maximum permissible system leakage capacitance is provided in the technical data.

Intended use also includes

- the observation of all information in the operating manual and
- compliance with test intervals.

In order to meet the requirements of the applicable standards, customised parameter settings must be made on the equipment in order to adapt it to local equipment and operating conditions. Please heed the limits of the range of application indicated in the technical data.

Do not make any unauthorised changes to the device. Only use spare parts and optional accessories sold or recommended by the manufacturer.

Caution: This equipment is not intended for use in residential environments and may not provide adequate protection to radio reception in such environments.

Any other use than that described in this manual is regarded as improper.

Device features

- ISOMETER® for IT AC systems with galvanically connected rectifiers or inverters and for IT DC systems (IT = unearthed systems)
- Automatic adaptation to the existing system leakage capacitance
- Combination of **AMP^{PLUS}** and other profile-specific measurement methods
- Two separately adjustable response value ranges of 1 kΩ ... 10 MΩ
- Graphical LC display
- Connection monitoring (monitoring of the measuring lines)
- Automatic device self test
- Graphical representation of the insulation resistance over time (isoGraph)
- History memory with real-time clock (buffer for three days) for storing 1023 alarm messages with date and time
- Current or voltage output 0(4)...20 mA, 0...400 µA, 0...10 V, 2...10 V (galvanically separated), which is analogous to the measured insulation value of the system
- Freely programmable digital inputs and outputs
- Remote setting via the Internet or Intranet (web server/option: COMTRAXX® gateway)
- Remote diagnosis via the Internet (made available by Bender Service only)
- isoData: permanent uninterrupted data transmission
- RS-485/BS (Bender sensor bus) for data exchange with other Bender devices via Modbus RTU protocol
- BCOM, Modbus TCP and web server
- ISOnet: Internal separation of the ISOMETER® from the IT system to be monitored (e.g. if several IT systems are interconnected)
- ISOnet priority: permanent priority of a device within the network
- ISLoop: special function for ring systems (all systems are coupled)

Product description

The ISOMETER® is an insulation monitoring device for IT systems in accordance with IEC 61557-8.

It is universally applicable in AC, 3(N)AC, AC/DC and DC systems. AC systems may include extensive DC-supplied loads (such as rectifiers, inverters, variable-speed drives).

Special ISOMETER® characteristics

The ISOMETER® iso685-D... belongs to the iso685 device family and features an integrated display.

The ISOMETER® iso685-S... is the sensor variant of the iso685 device family. The only difference between this variant and the ISOMETER® iso685-D... is that it does not have a display. The ISOMETER® iso685-S... must be used in combination with a front panel through which it is operated. The operation of the front panel is equal to the operation of the ISOMETER® with an integrated display.

- i** Only the sensor variant (i.e. ISOMETER® iso685-S...) can be connected to the front panel. Connection to the display variant (i.e. ISOMETER® iso685-D...) is not possible.

Function description

The insulation monitoring device continuously monitors the entire insulation resistance of an IT system during operation and triggers an alarm when the value falls below a preset response value.

For measurement, the device has to be connected between the IT system and the protective earth conductor (PE). A measuring current in the μA range is superimposed onto the system which is recorded and evaluated by a microprocessor-controlled measuring circuit. The measuring time is dependent on the selected measurement profiles, the system leakage capacitance, the insulation resistance and possible system-related disturbances.

The response values and other parameters are set using a commissioning wizard as well as via different setup menus using the device buttons and a graphical LC display. The selected settings are stored in a permanent fail-safe memory. Different languages can be selected for the setup menus as well as the messages indicated on the display. The device utilises a clock for storing fault messages and events in a history memory with time and date stamp. The settings can be password protected to prevent unauthorised changes.

To ensure proper functioning of connection monitoring, the device requires the setting of the system type 3AC, AC or DC and the required use of the appropriate terminals L1/+, L2, L3/-.

To extend the operating range of the nominal voltage, various coupling devices are available as accessories, which can be selected and adjusted via a menu.

The insulation monitoring device iso685... is able to measure the insulation resistance reliably and precisely in all common IT systems. Due to various applications, system types, operating conditions, application of variable-speed drives, high system leakage capacitances etc., the measuring instruments must be able to meet varying requirements in order to ensure an optimised response time and relative uncertainty. Therefore different measuring profiles can be selected with which the device can be optimally adjusted.

If the preset response value falls below the value of Alarm 1 and/or Alarm 2, the associated alarm relays switch, the **ALARM 1** or **ALARM 2** LEDs light, and the measured value is shown on the LC display (in case of insulation faults in DC systems, a trend graph for the faulty conductor L+/L- is displayed). If the fault memory is activated, the fault message will be stored.

Pressing the **RESET** button resets the insulation fault message, provided that the insulation resistance displayed at the time of the resetting is at least 25 % above the actual response value.

As additional information, the quality of the measuring signal and the time required to update the measured value are shown on the display. A poor signal quality (1-2 bars) may be an indication that the wrong measurement profile is selected.

The ISOMETER® has an internal system isolating switch, which makes it possible to operate several ISOMETER®s in coupled IT systems. For this purpose, the ISOMETER®s are connected via an Ethernet bus. The integrated ISONet function ensures that only one ISOMETER® is actively measuring at any time, while the other devices are completely isolated from the system and waiting in standby mode for measuring permission.

Interfaces

- Communication protocol Modbus TCP
- Communication protocol Modbus RTU
- BCOM for communication of Bender devices via Ethernet
- BS bus for communication of Bender devices (RS-485)
- isoData for recording and managing measured values
- Integrated web server for reading out measured values and setting parameters

Variants

iso685(W)-D...,
isox685(W)-D... Graphic LC display and operating controls.
 Cannot be combined with the FP200(W).

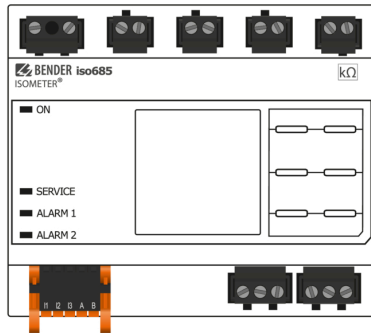

iso685(W)-S...,
isox685(W)-S... No display and no operating controls.
 Can only be operated in combination with the FP200(W).

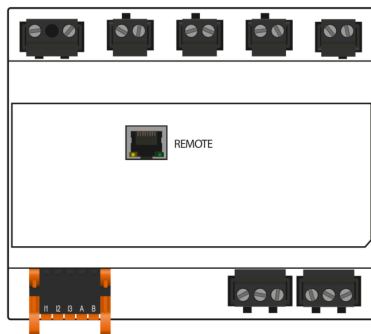

+

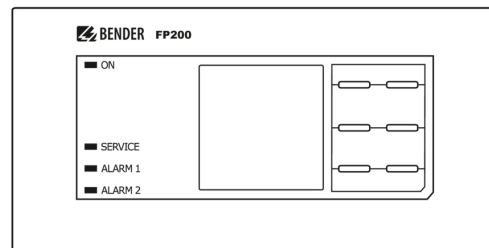

Connection

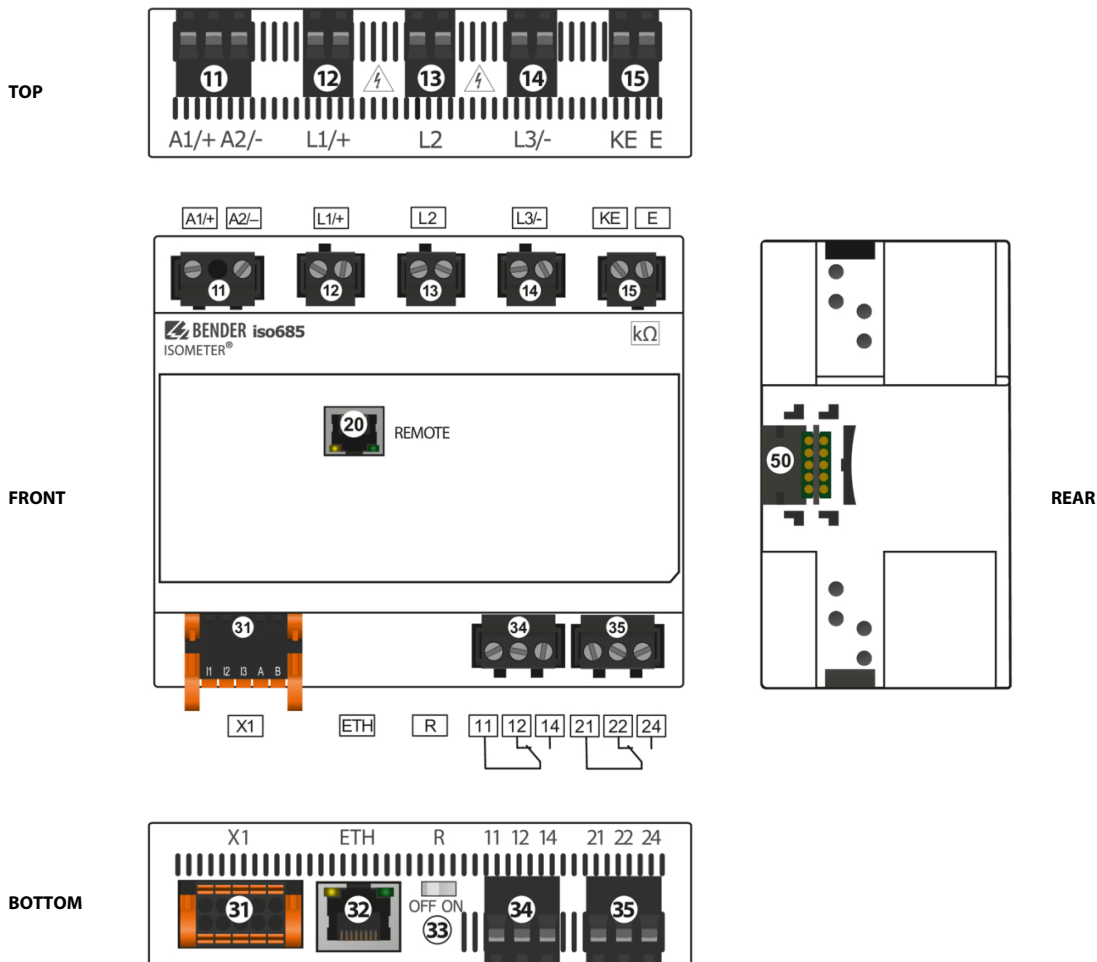

11	A1+, A2/-	Connection to the power supply voltage U_s
12	L1/+	Connector for the IT system to be monitored
13	L2	Connector for the IT system to be monitored
14	L3/-	Connector for the IT system to be monitored
15	KE, E	Connection to PE
20	X4	isoxx685(W)-S... only: connector for the FP200(W)
31	X1	Multifunctional I/O interface
32	ETH (X2)	Ethernet interface
33	R	Switchable terminating resistor for termination of the RS-485 interface
34	11 12 14	Connector for alarm relay 1
35	21 22 24	Connector for alarm relay 2
50	BB-Bus	isoxx685(W)-x-P... only: optional expansion interface for Bender products

i The connection between the iso685 device and an FP200(W) can be interrupted and restored at any time (Plug&Play), but is only recommended in a de-energised state.

Connection

Connection requirements

i Check proper connection!

Prior to commissioning the installation, check that the device has been properly connected and check the device functions. Perform a functional test using an earth fault via a suitable resistance.

Prevent measurement errors!

If a monitored AC system contains galvanically coupled DC circuits, the following applies: An insulation fault can only be detected with its correct value when the rectifier valves carry a minimum current of > 10 mA.

For UL applications

Use 60/75 °C copper lines only! For UL and CSA applications, the supply voltage must be protected via 5 A fuses.

Connection to a supply voltage

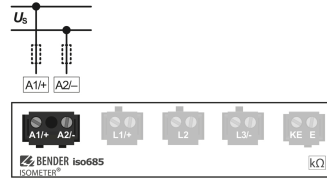

Connection to the X1 interface

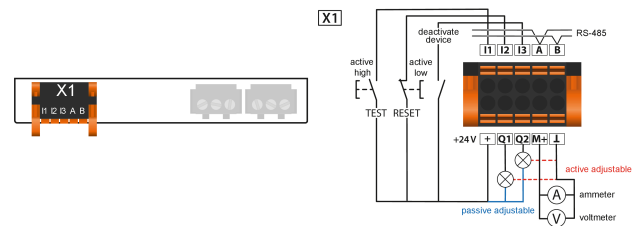

Connection to a 3(N)AC system

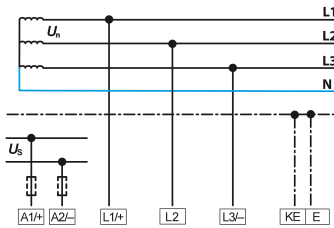

Connection to an AC system

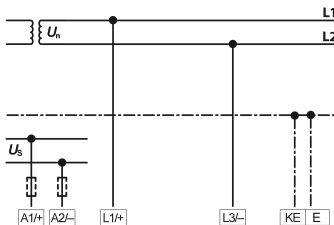

Connection to a DC system

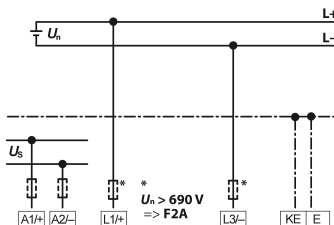

i In systems with a nominal system voltage of more than 690 V and with overvoltage category III, a fuse for the connection to the system to be monitored must be provided. * 2 A fuses recommended.

I1...I3	Configurable digital inputs (e.g. test, reset, ...)
A, B	Serial interface RS-485, termination by means of a DIP switch R .
+	Supply voltage of the inputs and outputs I, Q and M. Electrical overload protection. Automatic shutdown in the event of short circuits and transients (resettable). When supplied via an external 24 V source, A1/+ , A2/- must not be connected.
Q1, Q2	Configurable digital output
M+	Configurable analogue output (e.g. measuring instrument)
⊥	Reference potential ground

Connection to the Ethernet interface ETH

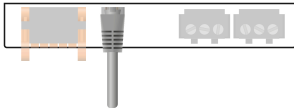

Connection with standard patch cable (RJ45/no crossover cable) to other ISOMETER®s or interconnection of several ISOMETER®s in star topology via a switch.

Connection of the relay interfaces 1 and 2

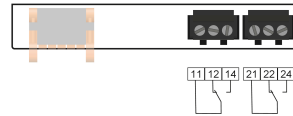

Relay 1	11 common contact	12 N/C contacts	14 N/O contacts
Relay 2	21 common contact	22 N/C contacts	24 N/O contacts

Connection using the AGH2045-4 (Art. No.: B914013)

Nominal voltage with rectifier:
AC 0...1300 V
Nominal voltage without rectifier:
AC 0...1650 V
Relative uncertainty:
15 % min. +/- 5 kΩ

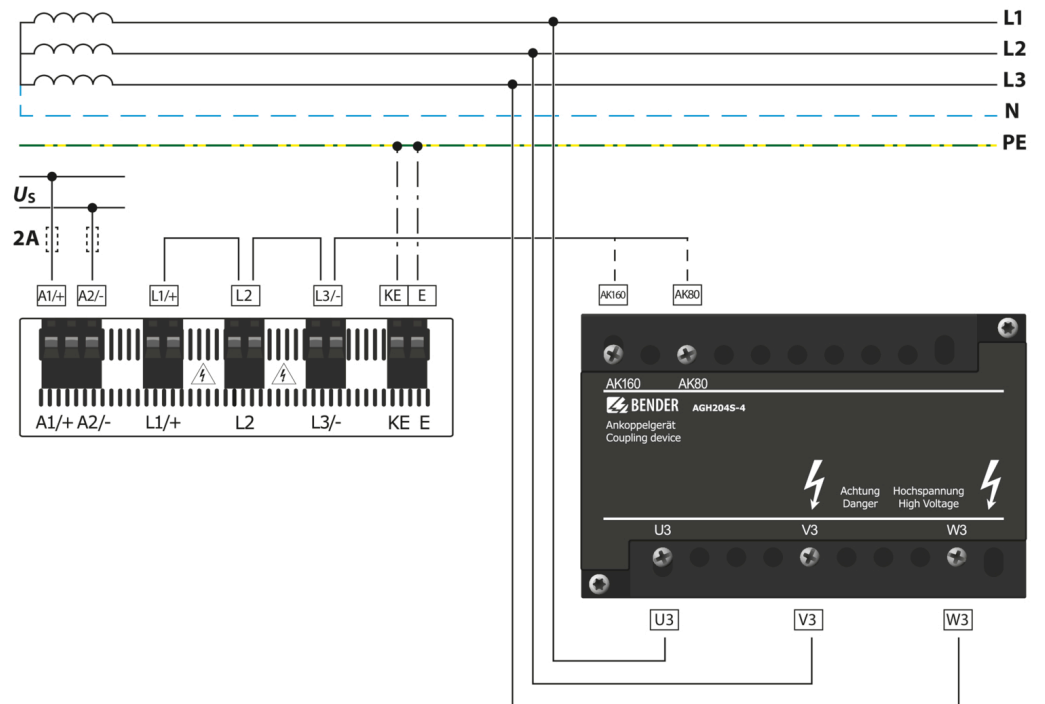

i For further connection examples, see manual.

Technical data

Insulation coordination acc. to IEC 60664-1/-3

Rated voltage	1000 V
Overtoltage category	III

Definitions

Measuring circuit (IC1)	L1/+, L2, L3/-
Supply circuit (IC2)	A1, A2
Output circuit 1 (IC3)	11, 12, 14
Output circuit 2 (IC4)	21, 22, 24
Control circuit (IC5)	(E, KE), X1, ETH, X3, X4

Rated impulse voltage

IC1/(IC2-5)	8 kV
IC2/(IC3-5)	4 kV
IC3/(IC4-5)	4 kV
IC4/IC5	4 kV

Rated insulation voltage

IC1/(IC2-5)	1000 V
IC2/(IC3-5)	250 V
IC3/(IC4-5)	250 V
IC4/IC5	250 V
Pollution degree outside ($U_n < 690$ V)	3
Pollution degree outside (690 V $< U_n < 1000$ V)	2

Protective separation (reinforced insulation) between

IC1/(IC2-5)	Overtoltage category III, 1000 V
IC2/(IC3-5)	Overtoltage category III, 300 V
IC3/(IC4-5)	Overtoltage category III, 300 V
IC4/IC5	Overtoltage category III, 300 V

Voltage test (routine test) according to IEC 61010-1

IC2/(IC3-5)	AC 2.2 kV
IC3/(IC4-5)	AC 2.2 kV
IC4/IC5	AC 2.2 kV

Supply voltage

Supply via A1/+, A2/-

Supply voltage range U_s	AC/DC 24 ... 240 V
Tolerance of U_s	-30 ... +15 %
Maximum permissible input current of U_s	650 mA
Frequency range of U_s	DC, 50 ... 400 Hz*
Tolerance of U_s frequency range	-5 ... +15 %
Power consumption, typical at DC	≤ 12 W
Power consumption, typical at 50/60 Hz	≤ 12 W/21 VA
Power consumption, typical at 400 Hz	≤ 12 W/45 VA

* At frequencies > 200 Hz, the connection of X1 and remote must be shockproof.
Only permanently installed devices which at least have overvoltage category II (300 V) may be connected.

Supply via X1

Supply voltage U_s	DC 24 V
Tolerance of U_s	-20 ... +25 %

IT system being monitored

Nominal system voltage range U_n	AC 0 ... 690 V DC 0 ... 1000 V
Nominal system voltage range U_n for UL applications	AC/DC 0 ... 600 V
Tolerance of U_n	AC/DC +15 %
Frequency range of U_n	DC 0.1 ... 460 Hz
Max. alternating voltage U^- (for $f_n < 4$ Hz)	$U^-_{max} = 50 \text{ V} \times (1 + f_n^2)$

Response values

Response value R_{an1} (ALARM 1)	1 kΩ ... 10 MΩ
Response value R_{an2} (ALARM 2)	1 kΩ ... 10 MΩ
Relative uncertainty (acc. to IEC 61557-8)	profile-dependent, ±15 %, min. ±1 kΩ
Hysteresis	25 %, min. 1 kΩ

Time response

Response time t_{an}	profile-dependent, typ. 4 s
at $R_F = 0.5 \times R_{an}$ (10 kΩ) and C_e (1 μF) acc. to IEC 61557-8	
Response time DC alarm at $C_e = 1$ μF	profile-dependent, typ. 2 s
Start-up delay t_{start}	0 s ... 10 min

Measuring circuit

Measuring voltage U_m	profile-dependent, ±10 V, ±50 V (see device profiles)
Measuring current I_m	≤ 403 μA
Internal resistance R_i, Z_i	≥ 124 kΩ
Permissible extraneous DC voltage U_{fg}	≤ 1200 V
Permissible system leakage capacitance C_e	profile-dependent, 0 ... 1000 μF

Measuring ranges

Measuring range f_n	0.1 ... 460 Hz
Tolerance, measurement of f_n	±1 % ±0.1 Hz
Voltage range, measurement of f_n	AC 25 ... 690 V
Measuring range U_n	AC 25 ... 690 V DC 0 ... 1000 V
Voltage range, measurement of U_n	AC/DC > 10 V
Tolerance, measurement of U_n	±5 % ±5 V
Measuring range C_e	0 ... 1000 μF
Tolerance, measurement of C_e	±10 % ±10 μF
Frequency range, measurement of C_e	DC, 30 ... 460 Hz
Insulation resistance, measurement of C_e	typ. > 10 kΩ
depending on the profile and coupling mode	

Display

Display	Graphic display 127 x 127 pixel, 40 x 40 mm*
Display range, measured value	0.1 kΩ ... 20 MΩ
Operating uncertainty (acc. to IEC 61557-8)	±15 %, min. 1 kΩ

* Indication is limited outside the temperature range -25 ... +55 °C.

LEDs

ON (operation LED)	green
SERVICE	yellow
ALARM 1	yellow
ALARM 2	yellow

Inputs/outputs (X1)

Cable length X1 (unshielded cable)	≤ 10 m
Cable length X1 (shielded cable, shield connected to PE on one side) recommended: J-Y(St)Y min. 2x0.8	≤ 100 m
Max output current for supply via X1+/X1GND per output	1 A
Max output current for supply via A1/A2 in total on X1	200 mA
Max output current for supply via A1/A2 in total on X1 between 16.8 V and 40 V	$I_{LmaxX1} = 10 \text{ mA} + 7 \text{ mA/V} \times U_s^*$

* U_s is the supply voltage of the ISOMETER®.
Negative values for I_{LmaxX1} are not permissible.

Digital inputs (I1, I2, I3)

Number	3
Operating mode, adjustable	active high, active low
Functions	off, test, reset, deactivate device, start initial measurement
Voltage	Low DC -3...5 V, High DC 11...32 V
Voltage tolerance	±10 %

Digital outputs (Q1, Q2)

Number	2
Operating mode, adjustable	active, passive
Functions	off, Ins. Alarm 1, Ins. Alarm 2, connection fault, DC- alarm*, DC+ Alarm*, symmetrical alarm, device error, common alarm, measurement complete, device inactive, DC offset alarm
Voltage	passive DC 0...32 V, active DC 0 / 19.2...32 V

* Only for $U_n \geq 50 \text{ V}$

Analogue output (M+)

Number	1
Operating mode, adjustable	linear, midscale point 28 kΩ/120 kΩ
Functions	insulation value, DC offset
Current (load)	0...20 mA (< 600 Ω) 4...20 mA (< 600 Ω) 0...400 μA (< 4 kΩ)
Voltage (load)	0...10 V (>1 kΩ) 2...10 V (>1 kΩ)
Tolerance related to the current/voltage final value %	±20 %

Interfaces

Field bus

Interface/protocol	web server/Modbus TCP/BCOM
Data rate	10/100 Mbit/s, autodetect
Max. number of Modbus requests	< 100/s
Cable	min. CAT 6
Cable length	≤ 100 m
Connection	RJ45
IP address	DHCP/manually: 192.168.0.5
Net mask	255.255.255.0
BCOM address	system-1-0
Function	Communication interface

ISOnet

ISOnet number of devices	2...20
Maximum nominal system voltage ISOnet	AC, 690 V DC, 1000 V

ISOloop

ISOloop number of devices	2...10
---------------------------	--------

Sensor bus

Interface / protocol	RS-485 / isoData, BS bus, Modbus RTU
Data rate Mode 1	9.6 kBd
Cable: twisted pairs, shield connected to PE on one side	recommended: J-Y(St)Y min. 2x0.8
Cable length (depending on the baud rate)	≤ 1200 m
Connection	terminals X1A, X1B
Terminating resistor	120 Ω, can be connected internally
Device address	1...90

Switching elements

Switching elements	2 changeover contacts
Operating mode	n/c / n/o
Contacts (11-12-14 / 21-22-24)	off, Ins. Alarm 1, Ins. Alarm 2, connection fault, DC- alarm*, DC+ alarm*, symmetrical alarm, device error, common alarm, measurement complete, device inactive, DC offset alarm
Electrical endurance at rated operating conditions	10,000 operating cycles
* Only for $U_n \geq 50 \text{ V}$	

Contact data acc. to IEC 60947-5-1

Utilisation category	AC-13 / AC-14 / DC-12 / DC-12 / DC-12 / DC-12
Rated operational voltage	230 V / 230 V / 24 V / 48 V / 110 V / 220 V
Rated operational current	5 A / 3 A / 1 A / 1 A / 0.2 A / 0.1 A
Rated insulation voltage at ≤ 2000 m AMSL	250 V
Rated insulation voltage at ≤ 3000 m AMSL	160 V
Minimum contact rating	1 mA at AC/DC ≥ 10 V

Environment & EMC

EMC	IEC 61326-2-4
Operating temperature	-25...+55 °C
Transport	-40...+85 °C
Long-term storage	-40...+70 °C

Classification of climatic conditions acc. to IEC 60721 (with respect to temperature and rel. humidity)

Stationary use (IEC 60721-3-3)	3K22
Transport (IEC 60721-3-2)	2K11
Long-term storage (IEC 60721-3-1)	1K22

Classification of mechanical conditions acc. to IEC 60721

Stationary use (IEC 60721-3-3)	3M11
Transport (IEC 60721-3-2)	2M4
Long-term storage (IEC 60721-3-1)	1M12
Area of application	≤ 3000 m AMSL

Connection

Screw-type terminals

Nominal current	≤ 10 A
Tightening torque	0.5...0.6 Nm (5...7 lb-in)
Conductor sizes	AWG 24-12
Stripping length	7 mm
Wire cross-section	
rigid/flexible	0.2...2.5 mm ²
flexible with ferrule with/without plastic sleeve	0.25...2.5 mm ²
Multiple conductor, rigid	0.2...1 mm ²
Multiple conductor, flexible	0.2...1.5 mm ²
Multiple conductor, flexible with ferrule without plastic sleeve	0.25...1 mm ²
Multiple conductor, flexible with TWIN ferrule with plastic sleeve	0.5...1.5 mm ²

Push-wire terminals

Nominal current	≤ 10 A
Conductor sizes	AWG 24-12
Stripping length	10 mm
Wire cross-section	
rigid/flexible	0.2...2.5 mm ²
flexible with ferrule with/without plastic sleeve	0.25...2.5 mm ²
Multiple conductor, flexible with TWIN ferrule with plastic sleeve	0.5...1.5 mm ²

Push-wire terminals X1

Nominal current	≤ 8 A
Conductor sizes	AWG 24-16
Stripping length	10 mm
Wire cross-section	
rigid/flexible	0.2...1.5 mm ²
flexible with ferrule with/without plastic sleeve	0.25...1.5 mm ²
flexible with ferrule with plastic sleeve	0.25...0.75 mm ²

Other

Operating mode	continuous operation
Mounting position	display-oriented*
Degree of protection, internal components	IP40
Degree of protection, terminals	IP20
DIN rail mounting acc. to	IEC 60715
Screw mounting	3 x M4 with mounting clip
Enclosure material	polycarbonate
Flammability class (UL 94)	V-0
ANSI Code	64
Dimensions (W x H x D)	108 x 93 x 110 mm
Weight	< 390 g

* For best ventilation, align cooling slots vertically (0°).

At an alignment of 45° the max. operating temperature is reduced by 10 °C.

At an alignment fo 90° the max. operating temperature is reduced by 20 °C.

Option "W", data different from the standard version

Devices with the suffix **W** feature increased shock and vibration resistance. The electronics is covered with a special varnish to provide increased protection against mechanical stress and moisture.

Rated operational current for switching elements	max. 3 A (for UL applications)
--	--------------------------------

Ambient temperatures

Operating temperature	-40...+70 °C
Operating temperature for UL applications	-40...+65 °C
Transport	-40...+85 °C
Long-term storage	-40...+70 °C

Classification of climatic conditions acc. to IEC 60721

Stationary use (IEC 60721-3-3)	3K23
--------------------------------	------

Classification of mechanical conditions acc. to IEC 60721

Stationary use (IEC 60721-3-3)	3M12
--------------------------------	------

i Combination of ISOMETER® sensor variant with an FP200W: The requirements of option **W** will only be fulfilled when the ISOMETER® sensor variant is mounted on a DIN rail and connected to the FP200W via the patch cable. Refer also to the quick-start guide FP200 (Document number D00169).

Dimensions

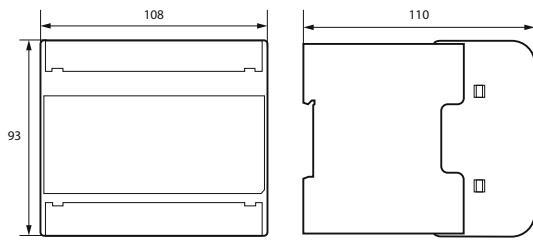

Dimensions in mm

Standards and certifications

The ISOMETER® has been developed in compliance with the following standards:

- DIN EN 61557-8 (VDE 0413-8): 2015-12
- IEC 61557-8: 2014-12
- IEC 61557-8: 2014/COR1:2016
- DIN EN 61557-8 Cor 1 (VDE 0413-8 Cor 1): 2016-12



Ordering details

Device

Type	Supply voltage U_s	Article number
iso685-D-B	AC 24...240 V; 50...400 Hz; DC 24...240 V	B91067020
iso685W-D-B *	AC 24...240 V; 50...400 Hz; DC 24...240 V	B91067020W
iso685-S-B + FP200	AC 24...240 V; 50...400 Hz; DC 24...240 V	B91067220
iso685W-S-B + FP200W *	AC 24...240 V; 50...400 Hz; DC 24...240 V	B91067220W

* Option **W**: Increased shock and vibration resistance 3K23; 3M12; Bezeichnung -40...+70 °C

Accessories

Description	Article number
iso685 Mechanical accessories comprising terminal cover, 2 mounting clips *	B91067903
iso685 connector kit for screw-type terminals *	B91067901
iso685 connector kit for push-wire terminals	B91067902

* included in the scope of delivery

Suitable system components

Type	Description	Article number
7204-1421	Suitable measuring instruments mid scale: 28 kΩ; 120 kΩ Current values: 0...400 μA; 0...20 mA	B986763
9604-1421		B986764
9620-1421		B986841
FP200	Display for front panel mounting	B91067904
FP200W*	Display for front panel mounting	B91067904W
iso685-S-B	ISOMETER® sensor variant * AC 24...240 V; 50...400 Hz; DC 24...240 V	B91067120
iso685W-S-B	ISOMETER® sensor variant * AC 24...240 V; 50...400 Hz; DC 24...240 V	B91067120W

* Only available with separate FP200(W) panel

Coupling devices

Type	Nominal voltage U_n	Article number
AGH150W-4	3(N)AC 0...1150 V; DC 0...1760 V	B98018006
AGH520S	AC/3(N)AC 0...7200 V;	B913033
AGH204S-4	AC 0...1650 V; with rectifier: AC 0...1300 V	B914013
AGH676S-4	AC 12 kV	B913055



Bender GmbH & Co. KG

Londorfer Straße 65
35305 Grünberg
Germany

Tel.: +49 6401 807-0
info@bender.de
www.bender.de



© Bender GmbH & Co. KG, Germany
Subject to change!
The specified standards take into account the
edition valid until 08.2024 unless otherwise
indicated.